

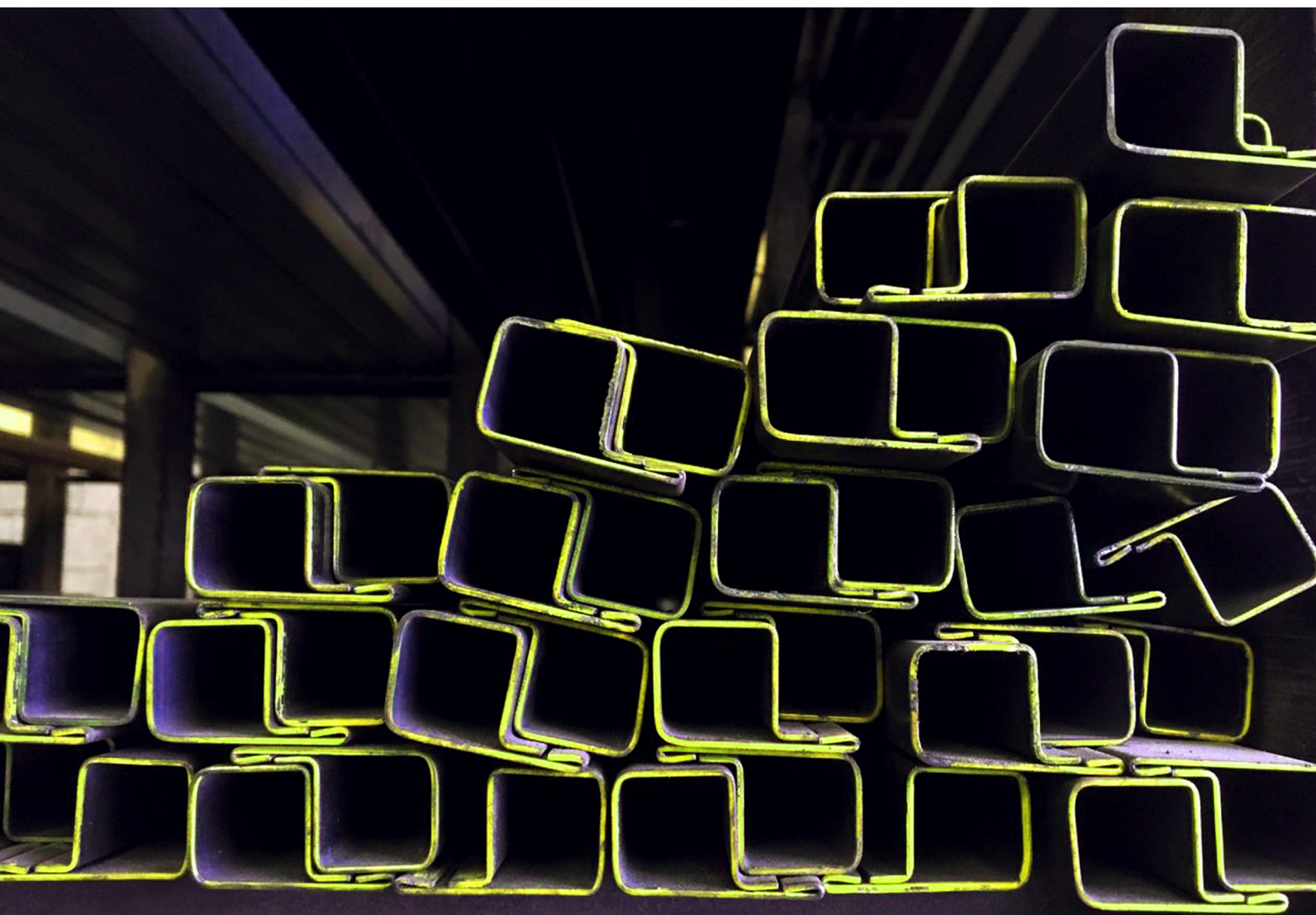

Perfil Serralheiro



RUA GALATEA, 1610 / 1638 | CARANDIRU | SÃO PAULO | CEP: 02068-000
+55 11 2223-3900 | 3571-1037 | WHATSAPP 11 99966-7089
www.ferronor.com.br | email: ferronor@ferronor.com.br

Cadeiras

CADEIRINHA FECHADA

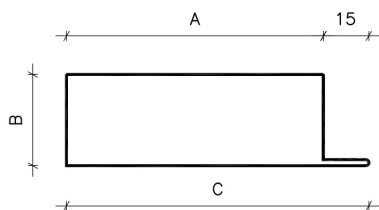

CODIGO	DIMENSÕES			PESO P/ BR (3m) # 16 FQ
	A	B	C	
22	25	25	40	4,32 Kg
163	30	25	45	4,68 Kg
177	35	25	50	5,05 Kg
178	50	25	65	6,15 Kg
23	65	25	80	7,25 Kg
237	80	25	95	8,34 Kg
12	25	30	45	5,05 Kg
173	35	32	50	5,56 Kg
174	50	32	65	6,66 Kg
40	65	32	80	7,76 Kg
175	80	32	95	8,86 Kg

CADEIRINHA ABERTA

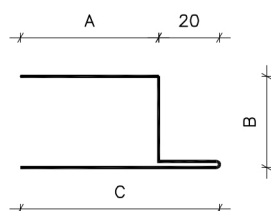

CODIGO	DIMENSÕES			PESO P/ BR (3m) # 16 FQ
	A	B	C	
171	30	25	45	3,90 Kg
160	35	25	50	4,36 Kg
172	50	25	65	5,40 Kg
14	25	30	45	4,00 Kg

CADEIRINHA DE ENGATE

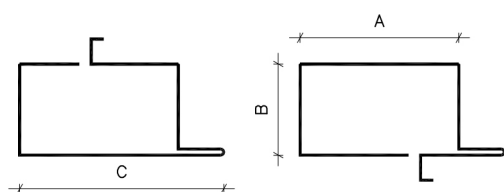

CODIGO	DIMENSÕES			PESO P/ BR (3m) # 16 FQ
	A	B	C	
218	35	25	50	5,70 Kg
219	35	25	50	5,70 Kg
216	50	25	65	6,80 Kg
217	50	25	65	6,80 Kg
186	35	32	50	6,10 Kg
187	30	25	45	6,10 Kg
184	50	32	65	7,10 Kg
185	50	32	65	7,10 Kg

MATA JUNTA

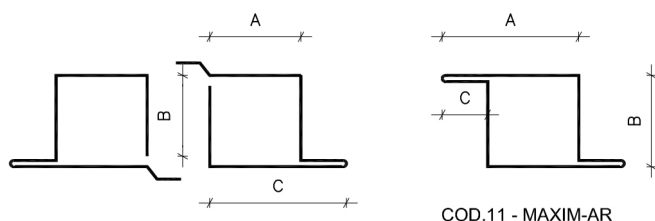

CODIGO	DIMENSÕES			PESO P/ BR (3m) # 16 FQ
	A	B	C	
215	35	25	50	5,70 Kg
214	35	25	50	5,70 Kg
213	50	25	65	6,80 Kg
212	50	25	65	6,80 Kg
191	35	32	50	6,10 Kg
190	30	25	45	6,10 Kg
189	50	32	65	7,20 Kg
188	50	32	65	7,20 Kg
11	45	30	20	6,80 Kg

ALMOFADA

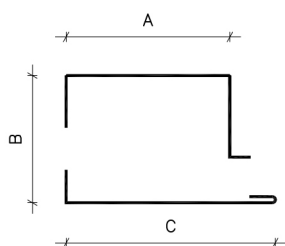

CODIGO	DIMENSÕES			PESO P/ BR (3m) # 16 FQ
	A	B	C	
94	150	25	165	13,47 Kg
235	200	25	215	17,13 Kg
193	300	25	315	24,45 Kg
97	150	32	165	13,98 Kg
234	200	32	215	17,64 Kg
192	300	32	315	24,96 Kg

Palhetas

PALHETA LISA

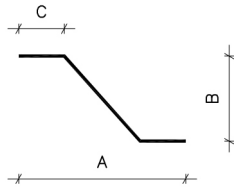

CODIGO	DIMENSÕES			PESO P/ BR (3m) # 16 FQ
	A	B	C	
226	55	28	15	2,20 Kg
228	60	23	15	2,22 Kg

PALHETA AMASSADA

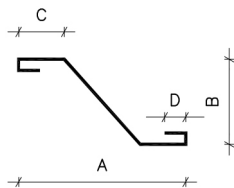

CODIGO	DIMENSÕES				PESO P/ BR (3m) # 16 FQ
	A	B	C	D	
226	75	28	15	9	3,60 Kg
228	75	23	15	9	3,40 Kg

PALHETA SEM VENTILAÇÃO

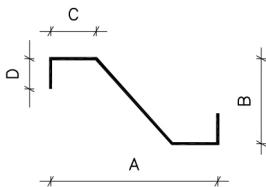

CODIGO	DIMENSÕES				PESO P/ BR (3m) # 16 FQ
	A	B	C	D	
90	80	27	20	9	4,00 Kg
91	80	22	20	9	3,49 Kg

PALHETA SEM VENTILAÇÃO AMASSADA

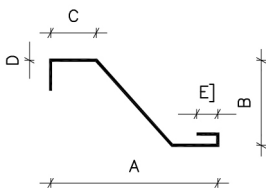

CODIGO	DIMENSÕES					PESO P/ BR (3m) # 16 FQ
	A	B	C	D	E	
55	55	28	12	26	-	2,50 Kg
56	60	23	12	21	-	2,90 Kg
57	75	28	15	26	9	3,50 Kg
58	75	23	15	21	9	3,90 Kg

Coluna | Soleira | Batedor | Guia Stanley

COLUNA DE CENTRO

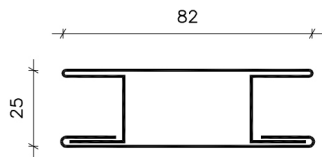

CODIGO	ESP.	PESO P/ BR (3m)
19	1,50	11,87 Kg
279	1,20	9,50 Kg
278	1,55	12,20 Kg
280	1,25	10,00 Kg

SOLEIRA DE REBITE

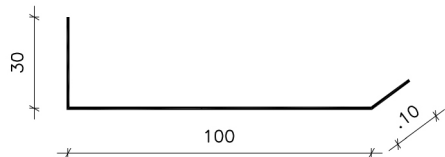

CODIGO	ESP.	PESO P/ BR (3m)
20	1,50	5,10 Kg
270	1,55	5,10 Kg

BATEDOR

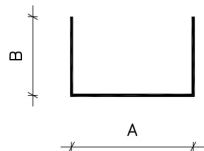

CODIGO	DIMENSÕES		PESO P/ BR (3m)
	A	B	# 16 FQ
231	32	20	2,42 Kg
44	37	15	2,25 Kg
45	37	20	2,60 Kg
197	40	20	2,70 Kg
49	47	20	3,00 Kg

MINI GUIA

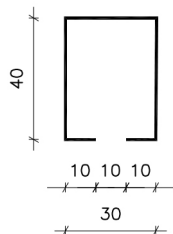

CODIGO	ESP.	COMPR.	PESO P/ BR (3m)
10	1,50	3000	4,25 Kg

STANLEY

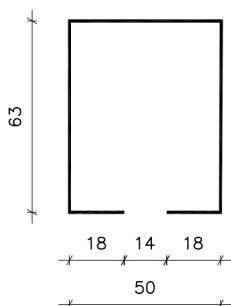

CODIGO	ESP.	COMPR.	PESO P/ BR (6m)
18	1,50	6000	14,40 Kg

Guia lateral | Baguetes | Soleiras

GUIA LATERAL

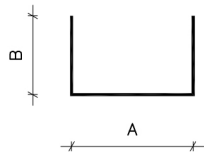

CODIGO	DIMENSÕES		PESO P/ BR (6m)
	A	B	# 16 FQ
233	28	28	2,90 Kg

BAGUETES

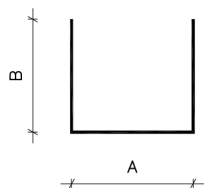

CODIGO	DIMENSÕES		PESO P/ BR (6m)
	A	B	# 16 FQ
300	3/8	3/8	1,70 Kg
302	3/4	3/4	3,85 Kg
301	1/2	1/2	2,20 Kg
303	1/2	1/2	2,40 Kg
304	3/4	3/4	2,50 Kg
357	3/4	3/4	2,70 Kg
402	5/8	5/8	3,00 Kg

SOLEIRA L

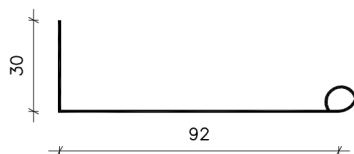

CODIGO	ESPESSURA	PESO P/ BR (6m)
274	1,55	10,00 Kg
275	1,50	10,00 Kg

SOLEIRA T



CODIGO	ESPESSURA	PESO P/ BR (6m)
272	1,55	12,87 Kg
276	1,50	12,75 Kg

Perfil "U" | Guia lateral Profunda

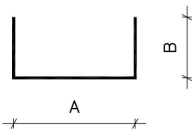
PERFIL U"	CODIGO	DIMENSÕES		PESO P/ METRO
		A	B	# 16 FQ
	247	10	10	0,36 Kg
	246	12	13	0,43 Kg
	245	13	13	0,47 Kg
	248	20	10	0,48 Kg
	232	20	13	0,55 Kg
	290	20	20	0,72 Kg
	291	25	25	0,90Kg
	292	25	28	0,97 Kg
	293	25	32	1,09Kg
	225	28	15	0,70 Kg
	233	28	28	1,01 Kg
	294	28	32	1,34Kg
	231	32	20	0,86 Kg
	295	35	35	1,26Kg
	197	40	20	0,96 Kg
	296	40	40	1,44 Kg
	198	50	20	1,08 Kg
	45	50	25	1,20 Kg
	199	60	20	1,20 Kg
	49	76	38	1,82 Kg
	200	80	20	1,44 Kg
	201	100	20	1,68 Kg
	50	100	40	2,16 Kg
	43	120	15	1,80 Kg
	52	127	50	2,72 Kg
	53	150	50	3,00 Kg
	297	200	16	2,78 Kg
	298	200	20	2,88 Kg
	299	300	16	3,98 Kg
	194	300	20	4,08 Kg
	300	400	16	5,18 Kg
	301	400	20	5,28 Kg

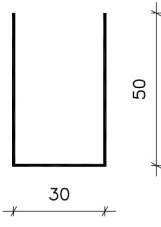
GUIA LATERAL PROFUNDA	CODIGO	DIMENSÕES		PESO P/ BARRA
		A	B	# 14 GALV
	20.01.14.004665	30	50	12,0 Kg
	20.01.14.004666	30	70	16,0 Kg
	20.01.14.000021	30	100	22,0 Kg

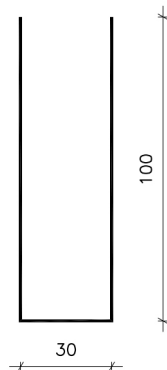
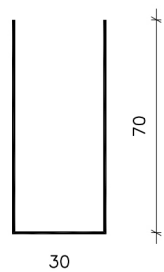
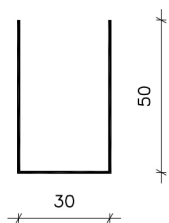

Perfis para vitrô

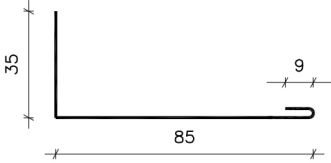
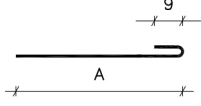
TAMPA L	CODIGO	PESO P/ BR (3m)	TAMPA RETA	CODIGO	DIM.	PESO P/ BR (3m)
		# 16 FQ			A	# 16 FQ
	5	4,70 Kg		6	65	2,70 Kg
				17	55	2,30 Kg

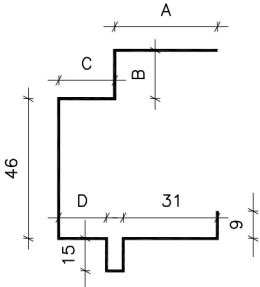
CAIXÃO 1-2	CODIGO	DIMENSÕES				PESO P/ BR (3m)
		A	B	C	D	# 16 FQ
	1	37	14	21	22	7,20 Kg
	2	39	16	28	29	7,70 Kg

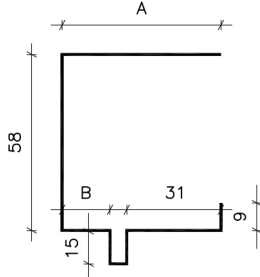
CAIXÃO 3-4	CODIGO	DIMENSÕES		PESO P/ BR (6m)
		A	B	# 16 FQ
	3	72	22	7,70 Kg
	4	79	29	8,70 Kg

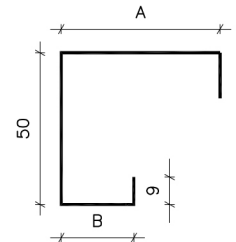
CAIXA G	CODIGO	DIMENSÕES		PESO P/ BR (6m)
		A	B	# 16 FQ
	7	58	33	5,50 Kg
	8	45	29	5,10 Kg
	9	40	22	4,40 Kg

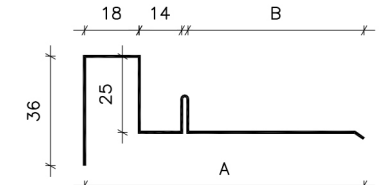
PEITORIL	CODIGO	DIMENSÕES		PESO P/ BR (3m)
		A	B	# 16 FQ
	46	105	58	6,75 Kg
	47	120	72	7,00 Kg

Batentes | Perfil Zee e Tee

BATENTE RETO

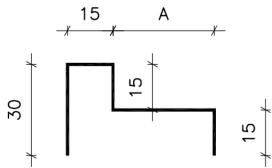

CODIGO	DIMENSÕES	PESO P/ BR (3m)
	A	# 16 FQ
195	27	3,57 Kg
196	35	3,80 Kg
208	42	4,10 Kg

BATENTE MODULAR

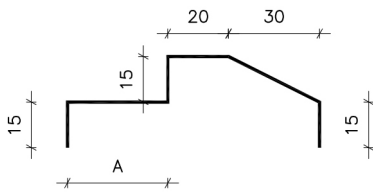

CODIGO	DIMENSÕES	PESO P/ BR (3m)
	A	# 16 FQ
209	27	4,20 Kg
204	35	4,60 Kg
205	42	5,00 Kg

PERFIL TEE

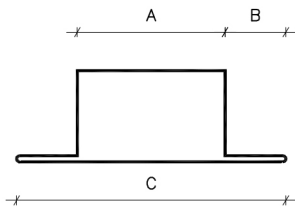

CODIGO	DIMENSÕES			PESO P/ BR (3m)
	A	B	C	# 16 FQ
167	20	25	50	5,05 Kg
164	25	25	55	5,42 Kg
161	30	25	60	5,78 Kg
182	35	25	65	6,15 Kg
183	50	25	80	7,25 Kg
39	65	25	95	8,34 Kg
13	25	25	65	6,51 Kg
166	20	32	50	5,56 Kg
179	35	32	65	6,70 Kg
181	50	32	80	7,76 Kg
180	65	32	95	8,86 Kg

PERFIL ZEE

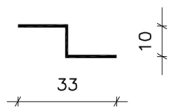
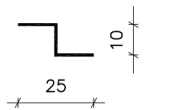

CODIGO	PESO P/ BR (3m)
	# 16 FQ
25	1,12 Kg
26	1,26 Kg

PERFIL L

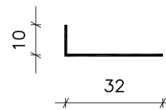

CODIGO	PESO P/ BR (3m)
	# 16 FQ
27	1,37 Kg

PERFIL ZEE

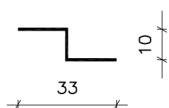
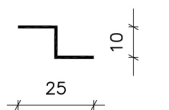

CODIGO	PESO P/ BR (3m)
	# 16 FQ
25	1,12 Kg
26	1,26 Kg

PERFIL L

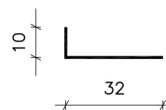

CODIGO	PESO P/ BR (3m)
	# 16 FQ
27	1,37 Kg

Lambril | Degrau | Patamar

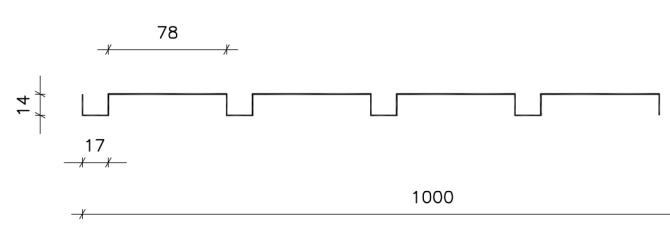
LAMBRIL FACHADA		CODIGO	ESP.	COMPR.	PESO P/ PÇ
		1346	0,43	2000	8,26 Kg
		1346	0,43	2500	10,32 Kg
		1346	0,43	3000	12,38 Kg

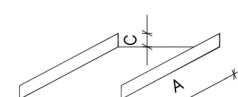
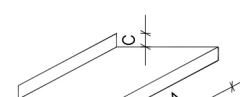
DEGRAU RETO		DIMENSÕES			
CODIGO	U	Z	A	B	C
					
	926	988	500	270	25
	932	990	600	270	25
	935	994	700	270	25
	942	1000	800	270	25
	998	991	900	270	40
	950	993	1000	270	40
			1200	270	40

CHAPA XADREZ - ESP. 2,65mm

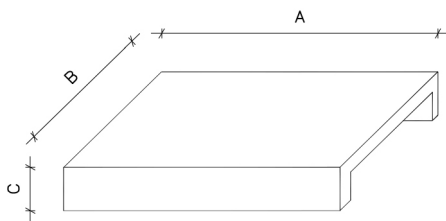

DEGRAU CARACOL		DIMENSÕES		
CODIGO	A	B	C	
				
	410	500	300	3"
	415	550	300	3"
	420	600	300	3"
	425	650	300	3"
	427	700	300	3"
	429	750	300	3"
	430	800	300	3"

CHAPA XADREZ - ESP. 2,65mm

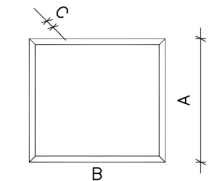
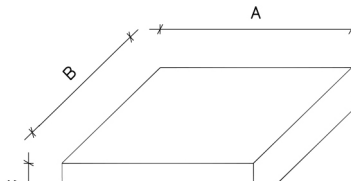
PATAMAR		DIMENSÕES		
CODIGO	A	B	C	
				
	437	500	500	25
	439	550	550	25
	441	600	600	25
	443	650	650	25
	445	700	700	25
	446	750	750	25
	449	800	800	25
	447	850	850	25
	448	900	900	40
	434	1000	1000	40

CHAPA XADREZ - ESP. 2,65mm

Caixaria

TRAVESSÃO	TRAVESSÃO	PESO P/ BR (3m)
		# 1,11 GALV
	130 X 80	11,20 Kg
	150 X 80	12,30 Kg
	180 X 80	13,90 Kg
	200 X 80	15,00 Kg

CONTRAPESO	CONTRAPESO	PESO P/ BR (1m)
		# 1,11 GALV
	100 X 110	3,64 Kg
	120 X 130	4,44 Kg
	150 X 160	5,32 Kg
	170 X 180	6,12 Kg

CAIXA	TRAVESSÃO	PESO P/ BR (3m)
		# 1,11 GALV
	130 X 130	10,90 Kg
	150 X 150	12,50 Kg
	180 X 180	14,90 Kg
	200 X 200	16,50 Kg

GUIA	GUIA	PESO P/ BR (3m)
		# 1,55 GALV
	54 X 50	5,50 Kg
	67 X 40	5,60 Kg

TAMPA	TAMPA	PESO P/ BR (3m)
		# 1,11 GALV
	130 X 100	3,94 Kg
	150 X 120	4,47 Kg
	180 X 150	5,30 Kg
	200 X 170	5,80 Kg

KIT BASCULANTE	PESO P/ BR (3m)
	# 1,11 GALV
130 X 130	48 Kg
150 X 150	54 Kg
180 X 180	62 Kg
200 X 200	68 Kg

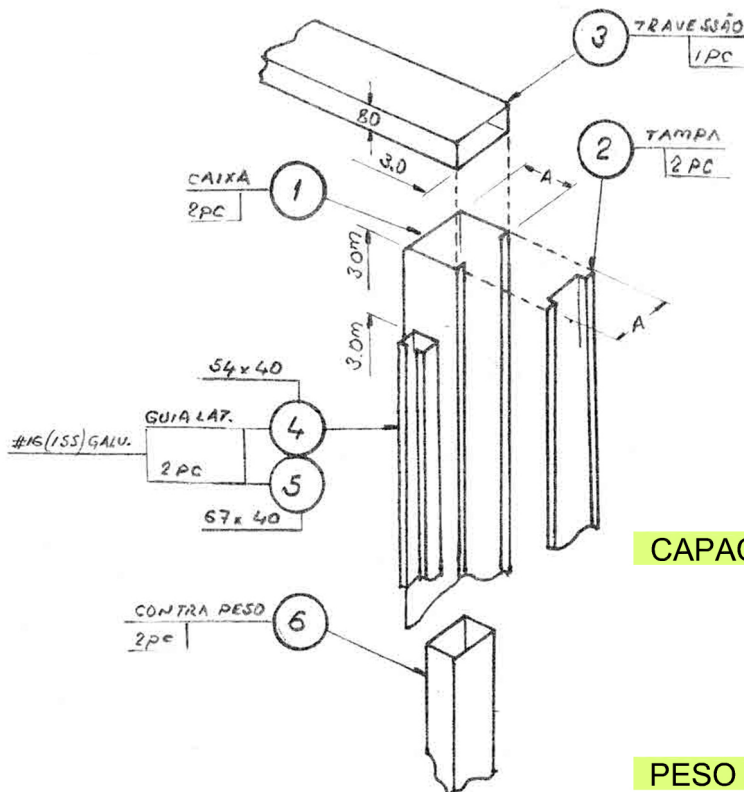

CAPACIDADE / KIT

150 X 150	140 Kg
180 X 180	180 Kg
200 X 200	220 Kg

PESO / PEÇA

	1	2	3	4	5	6	PESO TOTAL	
	Kg	Kg	Kg	Kg	Kg	Kg	c/ guia 4	c/ guia 5
150 X 150	25,0	9,0	12,3	11,0	11,2	9,0	66,30	66,50
180 X 180	30,0	10,6	14,0	11,0	11,2	10,8	76,40	76,60
200 X 200	33,0	11,6	15,0	11,0	11,2	12,4	83,00	83,20



RUA GALATEA, 1610 / 1638 | CARANDIRU | SÃO PAULO | CEP: 02068-000
+55 11 2223-3900 | 3571-1037 | WHATSAPP 11 99966-7089
www.ferronor.com.br | email: ferronor@ferronor.com.br